

To revise the topics that you have covered at the end of Y12 and to give you an introduction to Y13 Further Maths, we would like you to complete five tasks.

For your first Further Maths lesson in September please bring:

- A large A4 folder with dividers
- The first two pages of instructions from this document with the relevant details filled in (print out or copy & complete)
- Dated & titled work on each of the five tasks listed below
- A list of any additional questions you might have as a result of completing the four tasks

Task 1: Consolidation - Ch. 1 Complex Numbers

- Complete the 2 exercises using your gapped notes / PowerPoint resource – be selective with your choice of practice (i.e. you don't need to use every question)
- Mark and correct all questions using the markschemes at the back of this document
- Note any questions or parts of questions that you had difficulty with

Task 2: Consolidation - Ch. 2 Roots of Polynomials

- Complete the 3 exercises using your gapped notes / PowerPoint resource – be selective with your choice of practice (i.e. you don't need to use every question)
- Mark and correct all questions using the markschemes at the back of this document
- Note any questions or parts of questions that you had difficulty with

Task 3: Preview - Ch. 10 Further Calculus

Complete the gapped notes for Volumes of Revolution and Mean Value using the examples provided inc Ex. 10A, Ex. 10B & mixed practice (full chapter from the textbook in this document). The four Calculus videos on this Further Maths channel will help improve your understanding: <https://www.youtube.com/playlist?list=PL-Ild-VM4eK-WsdWaV6MMiT15rhlcX9cy>

	Gapped notes completed	Exercise completed - comments e.g. learning points / content to review
Section 1: Volumes of revolution		
Section 2: Mean value of a function		
Mixed Exercise 10	N/A	

Task 4: Review - Ch. 1 Complex Numbers

- Complete all exam questions, ideally in retrieval conditions
- Mark and correct all questions using the markschemes at the back of this document
- Note any questions or parts of questions that you had difficulty with

Question	Score	Comments e.g. learning points / content to review
Jan 05		
June 06		
June 07		
Jan 08		
June 08		
June 09		
June 10		
Total	/42	

Task 5: Review - Ch. 2 Roots of Polynomials

- Complete all exam questions, ideally in retrieval conditions
- Mark and correct all questions using the markschemes at the back of this document
- Note any questions or parts of questions that you had difficulty with

Question	Score	Comments e.g. learning points / content to review
Jan 05		
June 05		
Jan 06		
Jan 07		
June 08		
Total	/47	

Task 1: Consolidation – Ch. 1 Complex Numbers

Exercise level 1

1. Find the roots of the following equations:

(i) $z^2 + 25 = 0$

(ii) $4z^2 + 9 = 0$

(iii) $z^2 - 2z + 2 = 0$

(iv) $4z^2 + 4z + 5 = 0$

2. Two complex numbers $4 - 3i$ and $2 + i$ are denoted by z and w respectively. Find, giving your answers in the form $x + yi$.

(i) $2z - 3w$

(ii) zw

(iii) $(iz)^2$

(iv) $z^* w$

3. In each of the following cases find

(a) $z_1 + z_2$

(b) $z_1 - z_2$

(c) $z_1 z_2$

(d) z_1^*

(e) z_2^*

(f) $z_1^* + z_2^*$

(g) $z_1^* - z_2^*$

(h) $z_1^* z_2^*$

(i) $z_1 = 2 + 3i; z_2 = 1 - 2i$

(ii) $z_1 = -2i; z_2 = 3 + i$

What do you notice about the results?

4. Find the quadratic equation which has roots $2 + 3i$ and $2 - 3i$.

5. Express these complex numbers in the form $x + yi$.

(a) $\frac{2}{3+i}$

(b) $\frac{2-i}{1+2i}$

6. Solve the equation $(2+i)z = 3+4i$.

7. One root of the quadratic equation $z^2 + az + b = 0$ where a and b are real, is the complex number $1 + 2i$.

(i) Write down the other root.

(ii) Find the values of a and b .

Exercise level 2

1. $z = -3 + 4i$ and $w = \frac{5 + 2i}{z}$

Find w , giving your answer in the form $a + bi$, where a and b are real.

2. Given that $z = (a + i)^4$ where a is real, find values for a such that

(i) z is real,

(ii) z is wholly imaginary.

3. Given that $a + bi$ is the conjugate of $(a + bi)^2$ find **all** possible pairs of values for a and b .

4. Simplify and write in the form $a + bi$:

(i) $\frac{1}{3 + 2i} + \frac{1}{3 - 2i}$

(ii) $3 + i + \frac{4}{3 - i}$

(iii) $\frac{3}{1 - i} - \frac{2i}{2 + i}$

5. Find values for a and b that satisfy each of the following:

(i) $(a + bi)(2 + i) = a - 3i$

(ii) $(a + i)(4 - bi) = 3b + 2ai$

6. By writing $(a + bi)^2 = 3 - 4i$, find values for a and b and hence find the square roots of $3 - 4i$.

7. Find the values of p and q given that one root of the equation $z^2 + pz + q = 0$ is:

(i) $2 - i$

(ii) $1 - 3i$

(iii) $2i$

(iv) $5 - 3i$

8. Given that $\frac{5}{a + bi} + \frac{2}{1 + 3i} = 1$, where a and b are real, find the values of a and b .

Section 1: Roots and coefficients

Exercise level 1

- Find the sum and product of the roots of the following quadratic equations.
 - $2x^2 + 9x - 5 = 0$
 - $5x^2 - x + 2 = 0$
 - $3x(x + 2) = 4x - 5$
- The roots of a cubic equation are α , β and γ . For each of the following cubic equations, find the value of $\alpha + \beta + \gamma$, $\alpha\beta + \beta\gamma + \gamma\alpha$ and $\alpha\beta\gamma$.
 - $x^3 - 3x^2 + 2x + 4 = 0$
 - $2x^3 + 5x - 3 = 0$
 - $3x^3 + x^2 - 4x - 1 = 0$
- The roots of $3x^2 + 11x - 4 = 0$ are α and β .
Find the quadratic equation with roots
 - $\alpha - 2$ and $\beta - 2$
 - 3α and 3β .
- If $p + q = 5$ and $p^2 + q^2 = 19$ find the value of pq and hence write down a quadratic equation with roots p and q .
- The roots of the quadratic equation $x^2 + x - 6 = 0$ are α and β . Find the value of $\alpha + \beta + \frac{1}{\alpha} + \frac{1}{\beta}$.
- Given that -1 and 4 are two roots of $x^3 + 5x^2 + ax + b = 0$ find the third root and values for a and b .

Section 1: Roots and coefficients

Exercise level 2

1. One root of $2x^2 - kx + k = 0$ is twice the other. Find k . You may assume that $k \neq 0$.
2. The two roots of $x^2 + (7 - p)x - p = 0$ differ by 5. Find the possible values for p .
3. If α and β are the roots of $ax^2 + bx + c = 0$ prove that
 - (i) if $\beta = 4\alpha$ then $4b^2 = 25ac$
 - (ii) if $\beta = \alpha + 1$ then $a^2 = b^2 - 4ac$
4. The roots of the equation $x^3 - 2x^2 - 4x + 3 = 0$ are α , β and γ . Without solving the equation, find the values of
 - (i) $\frac{1}{\alpha} + \frac{1}{\beta} + \frac{1}{\gamma}$
 - (ii) $(\alpha + 1)(\beta + 1)(\gamma + 1)$
 - (iii) $\alpha^2 + \beta^2 + \gamma^2$
5. If the roots of $x^3 + 5x^2 + hx + k = 0$ are α , 2α , and $\alpha + 3$ find α , h and k .
6. Solve the equation $24x^3 + 28x^2 - 14x - 3 = 0$ given that the roots are of the form α , $\frac{\alpha}{r}$ and αr .
7. The equation $6x^3 + 11x^2 + kx - 9 = 0$ has roots α , $\frac{1}{\alpha}$ and β . Find the value of k and solve the equation.
8. The roots of $x^3 - 2x^2 - x + 2 = 0$ are α , β , and γ . Find equations which have roots
 - (i) $2\alpha, 2\beta, 2\gamma$
 - (ii) $\alpha - 3, \beta - 3, \gamma - 3$
9. The roots of $x^4 + ax^3 + bx^2 + cx + d = 0$ are α , β , γ , and δ . Given that $\alpha + \beta = \gamma + \delta$, show that $a^3 + 8c = 4ab$.

Section 2: Complex roots of polynomials

Exercise level 1

1. One root of the quadratic equation $z^2 + pz + q = 0$, where p and q are real, is $4 - 5i$.
 - (i) Write down the other root of the quadratic equation.
 - (ii) Find the values of p and q .
2.
 - (i) Verify that $z = 1 + i$ is a root of the equation $z^3 - 2z + 4 = 0$.
 - (ii) Write down the other complex root.
 - (iii) Find the third root of the equation.
3. Find the real root of the equation $z^3 + z + 10 = 0$, given that one complex root is $1 - 2i$.
4. Given that $1 + 3i$ is a root of the equation $z^3 - 3z^2 + 12z - 10 = 0$, find the other two roots.
5. Solve the cubic equation $z^3 - 4z^2 + 6z - 4 = 0$ given that $z = 2$ is a root.

Markschemes for Tasks 1 & 2

Task 1: Complex Numbers

Solutions to Exercise level 1

1. (i) $z^2 + 25 = 0$

$$z^2 = -25$$

$$z = \pm 5i$$

(ii) $4z^2 + 9 = 0$

$$z^2 = -\frac{9}{4}$$

$$z = \pm \frac{3}{2}i$$

(iii) $z^2 - 2z + 2 = 0$

$$z = \frac{2 \pm \sqrt{4 - 4 \times 1 \times 2}}{2}$$

$$= \frac{2 \pm \sqrt{-4}}{2}$$

$$= \frac{2 \pm 2i}{2}$$

$$= 1 \pm i$$

(iv) $4z^2 + 4z + 5 = 0$

$$z = \frac{-4 \pm \sqrt{16 - 4 \times 4 \times 5}}{8}$$

$$= \frac{-4 \pm \sqrt{-64}}{8}$$

$$= \frac{-4 \pm 8i}{8}$$

$$= -\frac{1}{2} \pm i$$

2. (i) $2z - 3w = 2(4 - 3i) - 3(2 + i)$

$$= 8 - 6i - 6 - 3i$$

$$= 2 - 9i$$

(ii) $zw = (4 - 3i)(2 + i)$

$$= 8 - 6i + 4i - 3i^2$$

$$= 8 - 2i + 3$$

$$= 11 - 2i$$

$$(iii) \quad iz = i(4 - 3i) = 4i - 3i^2 = 4i + 3$$

$$\begin{aligned}(iz)^2 &= (4i + 3)^2 \\ &= 16i^2 + 24i + 9 \\ &= -16 + 24i + 9 \\ &= -7 + 24i\end{aligned}$$

$$\begin{aligned}(iv) \quad z^*w &= (4 - 3i)^*(2 + i) \\ &= (4 + 3i)(2 + i) \\ &= 8 + 6i + 4i + 3i^2 \\ &= 8 + 10i - 3 \\ &= 5 + 10i\end{aligned}$$

$$\begin{aligned}3. \quad (i) \quad (a) \quad z_1 + z_2 &= 2 + 3i + 1 - 2i = 3 + i \\ (b) \quad z_1 - z_2 &= 2 + 3i - 1 + 2i = 1 + 5i \\ (c) \quad z_1z_2 &= (2 + 3i)(1 - 2i) = 2 - 4i + 3i + 6 = 8 - i \\ (d) \quad z_1^* &= 2 - 3i \\ (e) \quad z_2^* &= 1 + 2i \\ (f) \quad z_1^* + z_2^* &= 2 - 3i + 1 + 2i = 3 - i \\ (g) \quad z_1^* - z_2^* &= 2 - 3i - 1 - 2i = 1 - 5i \\ (h) \quad z_1^*z_2^* &= (2 - 3i)(1 + 2i) = 2 + 4i - 3i + 6 = 8 + i\end{aligned}$$

$$\begin{aligned}(ii)(a) \quad z_1 + z_2 &= -2i + 3 + i = 3 - i \\ (b) \quad z_1 - z_2 &= -2i - 3 - i = -3 - 3i \\ (c) \quad z_1z_2 &= -2i(3 + i) = -6i + 2 = 2 - 6i \\ (d) \quad z_1^* &= 2i \\ (e) \quad z_2^* &= 3 - i \\ (f) \quad z_1^* + z_2^* &= 2i + 3 - i = 3 + i \\ (g) \quad z_1^* - z_2^* &= 2i - (3 - i) = -3 + 3i \\ (h) \quad z_1^*z_2^* &= 2i(3 - i) = 6i + 2 = 2 + 6i\end{aligned}$$

$$z_1^* + z_2^* = (z_1 + z_2)^*$$

$$z_1^* - z_2^* = (z_1 - z_2)^*$$

$$z_1^*z_2^* = (z_1z_2)^*$$

$$\begin{aligned}
 4. \quad z &= 2 \pm 3i \\
 (z-2) &= \pm 3i \\
 (z-2)^2 &= -9 \\
 z^2 - 4z + 4 &= -9 \\
 z^2 - 4z + 13 &= 0
 \end{aligned}$$

$$\begin{aligned}
 5. \quad (i) \quad \frac{2}{3+i} &= \frac{2(3-i)}{(3+i)(3-i)} \\
 &= \frac{2(3-i)}{9+1} \\
 &= \frac{2(3-i)}{10} = \frac{3-i}{5}
 \end{aligned}$$

$$\begin{aligned}
 (ii) \quad \frac{2-i}{1+2i} &= \frac{(2-i)(1-2i)}{(1+2i)(1-2i)} \\
 &= \frac{2-i-4i-2}{1+4} \\
 &= \frac{-5i}{5} = -i
 \end{aligned}$$

$$\begin{aligned}
 6. \quad (2+i)z &= 3+4i \\
 z &= \frac{3+4i}{2+i} \\
 &= \frac{(3+4i)(2-i)}{(2+i)(2-i)} \\
 &= \frac{6-3i+8i+4}{4+1} \\
 &= \frac{10+5i}{5} = 2+i
 \end{aligned}$$

$$\begin{aligned}
 7. \quad (i) \quad &\text{The other root is } 1-2i \\
 (ii) \quad z &= 1 \pm 2i \\
 (z-1) &= \pm 2i \\
 (z-1)^2 &= -4 \\
 z^2 - 2z + 1 &= -4 \\
 z^2 - 2z + 5 &= 0 \\
 \text{So } a &= -2, b = 5
 \end{aligned}$$

Solutions to Exercise level 2

$$\begin{aligned} 1. \quad w &= \frac{5+2i}{z} = \frac{5+2i}{-3+4i} \\ &= \frac{(5+2i)(-3-4i)}{(-3+4i)(-3-4i)} \\ &= \frac{-15-6i-20i+8}{9+16} \\ &= \frac{-7-26i}{25} \end{aligned}$$

$$\begin{aligned} 2. \quad z &= (a+i)^4 \\ &= a^4 + 4a^3i + 6a^2i^2 + 4ai^3 + i^4 \\ &= a^4 + 4a^3i - 6a^2 - 4ai + 1 \end{aligned}$$

(i) If z is real, $4a^3 - 4a = 0$

$$4a(a^2 - 1) = 0$$

$$4a(a+1)(a-1) = 0$$

so $a = 0, -1$ or 1 .

(ii) If z is wholly imaginary, $a^4 - 6a^2 + 1 = 0$

$$a^2 = \frac{6 \pm \sqrt{36-4}}{2} = 3 \pm 2\sqrt{2}$$

$$a = \pm \sqrt{3 \pm 2\sqrt{2}}$$

$$3. \quad (a+bi)^* = (a+bi)^2$$

$$a-bi = a^2 + 2abi - b^2$$

Equating imaginary parts: $-b = 2ab$

$$b + 2ab = 0$$

$$b(1+2a) = 0$$

$$b = 0 \text{ or } a = -\frac{1}{2}$$

Equating real parts: $a = a^2 - b^2$

If $b = 0$: $a = a^2$

$$a(1-a) = 0$$

$$a = 0 \text{ or } 1$$

$$\text{If } a = -\frac{1}{2}: -\frac{1}{2} = \frac{1}{4} - b^2$$

$$b^2 = \frac{3}{4}$$

$$b = \pm \frac{1}{2}\sqrt{3}$$

The possible values of a and b are: $a = b = 0$

$$a = 1, b = 0$$

$$a = -\frac{1}{2}, b = \pm \frac{1}{2}\sqrt{3}$$

$$\begin{aligned} 4. \quad (i) \quad \frac{1}{3+2i} + \frac{1}{3-2i} &= \frac{3-2i+3+2i}{(3+2i)(3-2i)} \\ &= \frac{6}{9+4} \\ &= \frac{6}{13} \end{aligned}$$

$$\begin{aligned} (ii) \quad 3+i + \frac{4}{3-i} &= 3+i + \frac{4(3+i)}{(3-i)(3+i)} \\ &= 3+i + \frac{4(3+i)}{9+1} \\ &= 3+i + \frac{2}{5}(3+i) \\ &= \frac{7}{5}(3+i) \end{aligned}$$

$$\begin{aligned} (iii) \quad \frac{3}{1-i} - \frac{2i}{2+i} &= \frac{3(1+i)}{(1-i)(1+i)} - \frac{2i(2-i)}{(2+i)(2-i)} \\ &= \frac{3+3i}{2} - \frac{4i+2}{5} \\ &= \frac{15+15i-8i-4}{10} \\ &= \frac{11+7i}{10} \end{aligned}$$

$$\begin{aligned} 5. \quad (i) \quad (a+bi)(2+i) &= a-3i \\ 2a+ai+2bi-b &= a-3i \end{aligned}$$

$$\text{Equating real parts:} \quad 2a-b=a$$

$$a=b$$

$$\text{Equating imaginary parts: } a+2b=-3$$

$$3a=-3$$

$$a=-1$$

$$a = -1, b = -1$$

(ii) $(a+i)(4-bi) = 3b+2ai$

$$4a - abi + 4i + b = 3b + 2ai$$

Equating real parts: $4a + b = 3b$

$$2a = b$$

$$-ab + 4 = 2a$$

$$-2a^2 + 4 = 2a$$

Equating imaginary parts: $a^2 + a - 2 = 0$

$$(a+2)(a-1) = 0$$

$$a = -2 \text{ or } a = 1$$

$$a = -2, b = -4 \text{ or } a = 1, b = 2.$$

6. $(a+bi)^2 = 3-4i$

$$a^2 + 2abi - b^2 = 3 - 4i$$

Equating imaginary parts: $2ab = -4$

$$b = -\frac{2}{a}$$

Equating real parts: $a^2 - b^2 = 3$

$$a^2 - \frac{4}{a^2} = 3$$

$$a^4 - 4 = 3a^2$$

$$a^4 - 3a^2 - 4 = 0$$

$$(a^2 - 4)(a^2 + 1) = 0$$

Since a is real, $a = \pm 2$ so $b = \mp 1$

The square roots of $3 - 4i$ are $2 - i$ and $-2 + i$.

7. (i) One root is $2 - i$ so the other root is $2 + i$

Equation is $(z-2+i)(z-2-i) = 0$

$$(z-2)^2 + 1 = 0$$

$$z^2 - 4z + 4 + 1 = 0$$

$$z^2 - 4z + 5 = 0$$

$$p = -4, q = 5$$

(ii) One root is $1 - 3i$ so the other root is $1 + 3i$

Equation is $(z-1+3i)(z-1-3i) = 0$

$$(z-1)^2 + 9 = 0$$

$$z^2 - 2z + 1 + 9 = 0$$

$$z^2 - 2z + 10 = 0$$

Task 2: Roots of Polynomials

Solutions to Exercise level 1

1. (i) $2x^2 + 9x - 5 = 0$

$$\text{Sum of roots} = -\frac{b}{a} = -\frac{9}{2}$$

$$\text{Product of roots} = \frac{c}{a} = \frac{-5}{2} = -\frac{5}{2}$$

(ii) $5x^2 - x + 2 = 0$

$$\text{Sum of roots} = -\frac{b}{a} = -\frac{-1}{5} = \frac{1}{5}$$

$$\text{Product of roots} = \frac{c}{a} = \frac{2}{5}$$

(iii) $3x(x+2) = 4x-5$

$$3x^2 + 6x = 4x - 5$$

$$3x^2 + 2x + 5 = 0$$

$$\text{Sum of roots} = -\frac{b}{a} = -\frac{2}{3}$$

$$\text{Product of roots} = \frac{c}{a} = \frac{5}{3}$$

2. (i) $x^3 - 3x^2 + 2x + 4 = 0$

$$\alpha + \beta + \gamma = -\frac{b}{a} = -\frac{-3}{1} = 3$$

$$\alpha\beta + \beta\gamma + \gamma\alpha = \frac{c}{a} = \frac{2}{1} = 2$$

$$\alpha\beta\gamma = -\frac{d}{a} = -\frac{4}{1} = -4$$

(ii) $2x^3 + 5x - 3 = 0$

$$\alpha + \beta + \gamma = -\frac{b}{a} = -\frac{0}{2} = 0$$

$$\alpha\beta + \beta\gamma + \gamma\alpha = \frac{c}{a} = \frac{5}{2}$$

$$\alpha\beta\gamma = -\frac{d}{a} = -\frac{-3}{2} = \frac{3}{2}$$

$$(iii) \quad 3x^3 + x^2 - 4x - 1 = 0$$

$$\alpha + \beta + \gamma = -\frac{b}{a} = -\frac{1}{3}$$

$$\alpha\beta + \beta\gamma + \gamma\alpha = \frac{c}{a} = \frac{-4}{3} = -\frac{4}{3}$$

$$\alpha\beta\gamma = -\frac{d}{a} = -\frac{-1}{3} = \frac{1}{3}$$

$$3. \quad 3x^2 + 11x - 4 = 0$$

$$\alpha + \beta = -\frac{11}{3}$$

$$\alpha\beta = -\frac{4}{3}$$

(i) For new equation,

$$\begin{aligned} \text{sum of roots} &= \alpha - 2 + \beta - 2 = (\alpha + \beta) - 4 \\ &= -\frac{11}{3} - 4 = -\frac{23}{3} \end{aligned}$$

$$\begin{aligned} \text{and product of roots} &= (\alpha - 2)(\beta - 2) = \alpha\beta - 2(\alpha + \beta) + 4 \\ &= -\frac{4}{3} + \frac{22}{3} + 4 = 10 \end{aligned}$$

$$\text{So for new equation, } -\frac{b}{a} = -\frac{23}{3} \text{ and } \frac{c}{a} = 10$$

Taking $a = 3$ gives $b = 23$ and $c = 30$

The new equation is $3x^2 + 23x + 30 = 0$

(ii) For new equation,

$$\begin{aligned} \text{sum of roots} &= 3\alpha + 3\beta = 3(\alpha + \beta) \\ &= 3 \times -\frac{11}{3} = -11 \end{aligned}$$

$$\begin{aligned} \text{and product of roots} &= 3\alpha \times 3\beta = 9\alpha\beta \\ &= 9 \times -\frac{4}{3} = -12 \end{aligned}$$

$$\text{So for new equation, } -\frac{b}{a} = -11 \text{ and } \frac{c}{a} = -12$$

Taking $a = 1$ gives $b = 11$ and $c = -12$

The new equation is $x^2 + 11x - 12 = 0$

$$4. \quad p + q = 5, \quad p^2 + q^2 = 19$$

$$(p+q)^2 = p^2 + q^2 + 2pq$$

$$5^2 = 19 + 2pq$$

$$6 = 2pq$$

$$pq = 3$$

$$\text{Sum of roots} = -\frac{b}{a} \Rightarrow 5 = -\frac{b}{a} \Rightarrow b = -5a$$

$$\text{Product of roots} = \frac{c}{a} \Rightarrow 3 = \frac{c}{a} \Rightarrow c = 3a$$

Putting $a = 1$ gives $b = -5$ and $c = 3$

A quadratic equation with roots p and q is $x^2 - 5x + 3 = 0$

5. $x^2 + x - 6 = 0$

$$\alpha + \beta = -1$$

$$\alpha\beta = -6$$

$$\alpha + \beta + \frac{1}{\alpha} + \frac{1}{\beta} = \alpha + \beta + \frac{\beta + \alpha}{\alpha\beta}$$

$$= -1 + \frac{-1}{-6}$$

$$= -1 + \frac{1}{6}$$

$$= -\frac{5}{6}$$

6. Sum of roots = -5

$$-1 + 4 + \alpha = -5$$

$$\alpha = -8$$

The third root is -8.

$$\sum \alpha\beta = a$$

$$(-1 \times 4) + (4 \times -8) + (-8 \times -1) = a$$

$$-4 - 32 + 8 = a$$

$$a = -28$$

$$\alpha\beta\gamma = -b$$

$$-1 \times 4 \times -8 = -b$$

$$b = -32$$

Section 1: Roots and coefficients

Solutions to Exercise level 2

1. Let the roots of the equation $2x^2 - kx + k = 0$ be α and 2α .

$$\text{Sum of roots: } \alpha + 2\alpha = \frac{k}{2} \Rightarrow \alpha = \frac{k}{6}$$

$$\begin{aligned} \text{Product of roots: } \alpha \times 2\alpha &= \frac{k}{2} \\ 4\alpha^2 &= k \\ 4\left(\frac{k}{6}\right)^2 &= k \\ k^2 &= 9k \\ k(k-9) &= 0 \end{aligned}$$

Since $k \neq 0$, the value of k must be 9.

2. Let the roots of the equation $x^2 + (7-p)x - p = 0$ be α and $\alpha + 5$.

$$\begin{aligned} \text{Sum of roots: } \alpha + \alpha + 5 &= -(7-p) \\ 2\alpha + 5 &= -7 + p \\ 2\alpha &= p - 12 \end{aligned}$$

$$\begin{aligned} \text{Product of roots: } \alpha(\alpha + 5) &= -p \\ \left(\frac{p-12}{2}\right)\left(\frac{p-12}{2} + 5\right) &= -p \\ (p-12)(p-12+10) &= -4p \\ (p-12)(p-2) &= -4p \\ p^2 - 14p + 24 &= -4p \\ p^2 - 10p + 24 &= 0 \\ (p-4)(p-6) &= 0 \\ p &= 4 \text{ or } p = 6. \end{aligned}$$

3. (i) $\beta = 4\alpha$

$$\text{Sum of roots: } \alpha + 4\alpha = -\frac{b}{a} \Rightarrow \alpha = -\frac{b}{5a}$$

Product of roots: $\alpha \times 4\alpha = \frac{c}{a}$

$$4\left(-\frac{b}{5a}\right)^2 = \frac{c}{a}$$

$$\frac{4b^2}{25a^2} = \frac{c}{a}$$

$$4b^2 = 25ac$$

(ii) $\beta = \alpha + 1$

Sum of roots: $\alpha + \alpha + 1 = -\frac{b}{a} \Rightarrow 2\alpha = -\frac{b}{a} - 1$

Product of roots: $\alpha(\alpha + 1) = \frac{c}{a}$

$$\left(-\frac{b}{2a} - \frac{1}{2}\right)\left(-\frac{b}{2a} - \frac{1}{2} + 1\right) = \frac{c}{a}$$

$$\left(\frac{b}{2a} + \frac{1}{2}\right)\left(\frac{b}{2a} - \frac{1}{2}\right) = \frac{c}{a}$$

$$\frac{b^2}{4a^2} - \frac{1}{4} = \frac{c}{a}$$

$$b^2 - a^2 = 4ac$$

$$a^2 = b^2 - 4ac$$

4. $\alpha + \beta + \gamma = -\frac{b}{a} = 2$

$$a\beta + \beta\gamma + \gamma\alpha = \frac{c}{a} = -4$$

$$a\beta\gamma = -\frac{d}{a} = -3$$

(i) $\frac{1}{\alpha} + \frac{1}{\beta} + \frac{1}{\gamma} = \frac{\beta\gamma + \alpha\gamma + \alpha\beta}{a\beta\gamma} = \frac{-4}{-3} = \frac{4}{3}$

(ii) $(\alpha + 1)(\beta + 1)(\gamma + 1) = (\alpha + 1)(\beta\gamma + \beta + \gamma + 1)$
 $= a\beta\gamma + a\beta + \alpha\gamma + \alpha + \beta\gamma + \beta + \gamma + 1$
 $= -3 - 4 + 2 + 1 = -4$

(iii) $(\alpha + \beta + \gamma)^2 = (\alpha + \beta)^2 + 2(\alpha + \beta)\gamma + \gamma^2$
 $= \alpha^2 + 2\alpha\beta + \beta^2 + 2\alpha\gamma + 2\beta\gamma + \gamma^2$

$$\begin{aligned}\alpha^2 + \beta^2 + \gamma^2 &= (\alpha + \beta + \gamma)^2 - 2(\alpha\beta + \beta\gamma + \gamma\alpha) \\ &= 2^2 - 2 \times -4 \\ &= 12\end{aligned}$$

5. $\sum \alpha = -5$

$$\alpha + 2\alpha + \alpha + 3 = -5$$

$$4\alpha = -8$$

$$\alpha = -2$$

The roots of the equation are -2, -4 and 1.

$$\sum \alpha\beta = h$$

$$(-2 \times -4) + (-4 \times 1) + (1 \times -2) = h$$

$$8 - 4 - 2 = h$$

$$h = 2$$

$$\alpha\beta\gamma = -k$$

$$-2 \times -4 \times 1 = -k$$

$$k = -8$$

6. Let the roots be $\frac{\alpha}{r}, \alpha, ar$

$$\alpha\beta\gamma = \frac{3}{24}$$

$$\frac{\alpha}{r} \times \alpha \times ar = \frac{1}{8}$$

$$\alpha^3 = \frac{1}{8}$$

$$\alpha = \frac{1}{2}$$

$$\sum \alpha = -\frac{28}{24}$$

$$\frac{\alpha}{r} + \alpha + ar = -\frac{7}{6}$$

$$\frac{1}{2} \left(\frac{1}{r} + 1 + r \right) = -\frac{7}{6}$$

$$3 + 3r + 3r^2 = -7r$$

$$3r^2 + 10r + 3 = 0$$

$$(3r + 1)(r + 3) = 0$$

$$r = -\frac{1}{3} \text{ or } -3$$

Roots are $-\frac{1}{6}, \frac{1}{2}$ and $-\frac{3}{2}$

Section 2: Complex roots of polynomials

Solutions to Exercise level 1

1. (i) The other root is $4 + 5i$

(ii) $z = 4 + 5i$

$$z - 4 = 5i$$

$$(z - 4)^2 = (5i)^2$$

$$z^2 - 8z + 16 = -25$$

$$z^2 - 8z + 41 = 0$$

$$\text{so } p = -8, q = 41$$

2. (i) Substituting $z = 1 + i$:

$$\begin{aligned} z^3 - 2z + 4 &= (1+i)^3 - 2(1+i) + 4 \\ &= 1 + 3i + 3i^2 + i^3 - 2 - 2i + 4 \\ &= 1 + 3i - 3 - i - 2 - 2i + 4 \\ &= 1 - 3 - 2 + 4 + (3 - 1 - 2)i \\ &= 0 \end{aligned}$$

so $z = 1 + i$ is a root

(ii) The other complex root is $z = 1 - i$

(iii) The sum of the roots is 0 since the coefficient of z^2 is zero.

Let the third root be α

$$1 + i + 1 - i + \alpha = 0$$

$$2 + \alpha = 0$$

$$\alpha = -2$$

so the other root is $z = -2$

3. $1 - 2i$ is a root, so $1 + 2i$ is also a root.

The sum of the roots is 0 since the coefficient of z^2 is zero.

Let the third root be α

$$1 + 2i + 1 - 2i + \alpha = 0$$

$$2 + \alpha = 0$$

$$\alpha = -2$$

The real root is $z = -2$.

4. Since $1+3i$ is a root, $1-3i$ is another root.

The sum of the roots is 3

Let the third root be α

$$1+3i+1-3i+\alpha=3$$

$$2+\alpha=3$$

$$\alpha=1$$

So the third root is $z=1$

5. $z=2$ is a root so $(z-2)$ is a factor

$$z^3 - 4z^2 + 6z - 4 = 0$$

$$(z-2)(z^2 - 2z + 2) = 0$$

$$z^2 - 2z + 2 = 0 \Rightarrow z = \frac{-(-2) \pm \sqrt{(-2)^2 - 4 \times 1 \times 2}}{2 \times 1}$$

$$\Rightarrow z = \frac{2 \pm \sqrt{-4}}{2} = \frac{2 \pm 2i}{2} = 1 \pm i$$

Task 3: Preview – Ch. 10 Further Calculus (flipped learning)

10 Further calculus

In this chapter you will learn how to:

- find the volume of a shape formed by rotating a curve around the x -axis or the y -axis
- find the mean value of a function.

Before you start ...

GCSE	You should know the formula for the volume of a cylinder.	1 Find the exact volume of a cylinder with base radius 4 cm and height 10 cm.
A Level Mathematics Student Book 1, Chapter 14	You should know how to find the definite integral of a polynomial.	2 Evaluate $\int_1^3 (x^4 + 2) dx$.
A Level Mathematics Student Book 1, Chapter 16	You should know that displacement is found by $\int v dt$.	3 Find the displacement in the first 10 seconds of a particle with velocity $3x^3 \text{ m s}^{-1}$.

What else can you do with calculus?

You have already seen several applications of calculus, such as finding tangents and normals to curves, optimisation, finding areas and converting between displacement, velocity and acceleration in kinematics. In this chapter, you will see two further applications – finding volumes and finding the mean value of a function.

Section 1: Volumes of revolution

In A Level Mathematics Student Book 1, Chapter 14, you saw that the area between a curve and the x -axis from $x = a$ to $x = b$ is given by $\int_a^b y \, dx$, as long as $y > 0$. In this section, you will use a similar formula to find the volume of a shape formed by rotating the curve about either the x -axis or the y -axis.

If a curve is rotated about the x -axis or the y -axis, the resulting shape is called a **solid of revolution** and the volume of that shape is referred to as the **volume of revolution**.

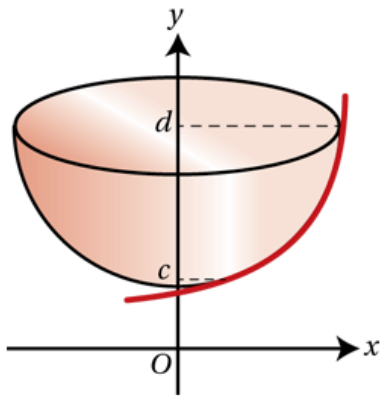
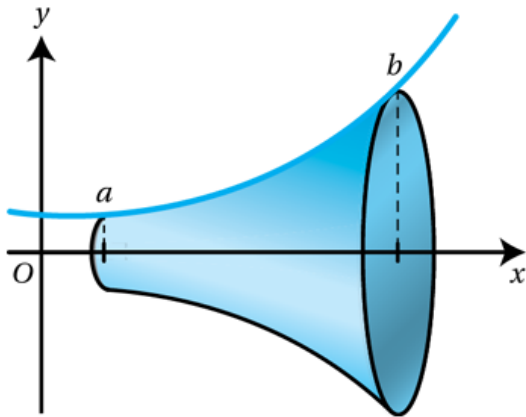

Key point 10.1

- When the curve $y = f(x)$ between $x = a$ and $x = b$ is rotated 360° about the x -axis, the volume of revolution is given by $V = \pi \int_a^b y^2 \, dx$.
- When the curve $y = f(x)$ between $y = c$ and $y = d$ is rotated 360° about the y -axis, the volume of revolution is given by $V = \pi \int_a^b y^2 \, dx$.

The proof of these results is very similar. The proof for rotation about the x -axis is given here.

PROOF 10

The solid can be split into small cylinders.

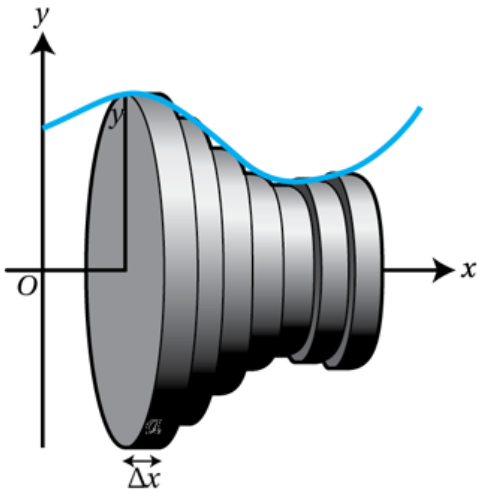

Draw an outline of a representative function to illustrate the argument.

The volume of each cylinder is $\pi y^2 \Delta x$.

The radius of each cylinder is the y -coordinate and the height is Δx .

The total volume is approximately:

You are starting at $x = a$ and stopping at $x = b$. It is only approximate because the volume of revolution is not exactly the same as the total volume of the cylinders.

$$V \approx \sum_a^b \pi y^2 \Delta x$$

However, as you make the cylinders smaller the volume gets more and more accurate. The sum then becomes an integral. You can leave π out of the integration and multiply by it at the end.

$$\begin{aligned} V &= \lim_{\Delta x \rightarrow 0} \sum_a^b \pi y^2 \Delta x \\ &= \int_a^b \pi y^2 dx \\ &= \pi \int_a^b y^2 dx \end{aligned}$$

WORKED EXAMPLE 10.1

The graph of $y = \sqrt{x^2 + 1}$, $0 \leq x \leq 3$, is rotated 360° about the x -axis.

Find, in terms of π , the volume of the solid generated.

$$\begin{aligned} V &= \pi \int_0^3 (x^2 + 1) dx \\ &= \pi \left[\frac{x^3}{3} + x \right]_0^3 \\ &= \pi \left[\left(\frac{3^3}{3} + 3 \right) - 0 \right] \\ &= 12\pi \end{aligned}$$

Use the formula: $v = \pi \int_a^b y^2 dx$.

Evaluate the definite integral.

To find the volume of revolution about the y -axis you will often have to rearrange the equation of the curve to find x in terms of y .

Common Error

Remember that the limits of the integration need to be in terms of y and not x .

WORKED EXAMPLE 10.2

The part of the curve $y = \frac{1}{x}$ between $x = 1$ and $x = 4$ is rotated 360° about the y -axis. Find the exact value of the volume of the solid generated.

$$\text{when } x = 1, y = \frac{1}{1} = 1$$

$$\text{when } x = 4, y = \frac{1}{4}$$

$$y = \frac{1}{x} \Rightarrow x = \frac{1}{y}$$

$$\begin{aligned} V &= \pi \int_a^b x^2 \, dy \\ &= \pi \int_{\frac{1}{4}}^1 \left(\frac{1}{y}\right)^2 \, dy \\ &= \pi \int_{\frac{1}{4}}^1 y^{-2} \, dy \\ &= \pi \left[-y^{-1}\right]_{\frac{1}{4}}^1 \\ &= \pi [(-1) - (-4)] \\ &= 3\pi \end{aligned}$$

Find the limits in terms of y .

Express x in terms of y .

Use the formula $V = \pi \int_a^b x^2 \, dy$, substituting in $x = \frac{1}{y}$.

You might also be asked to find a volume of revolution of an area between two curves.

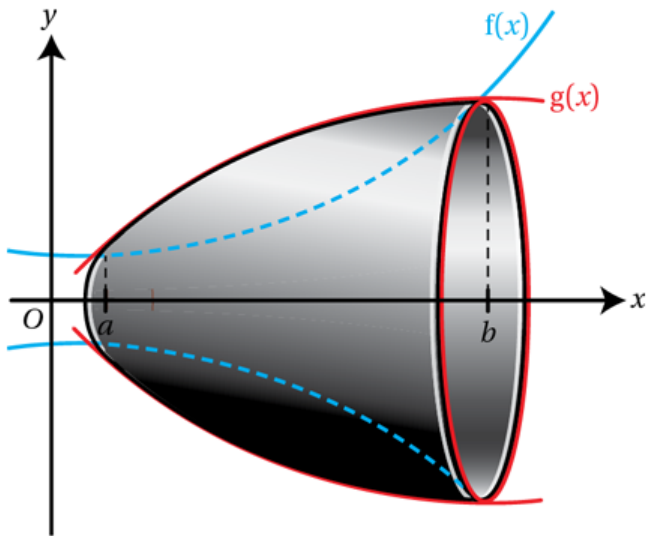

From the diagram you can see that the volume formed when the region R is rotated around the x -axis is given by the volume of revolution of $g(x)$ minus the volume of revolution of $f(x)$.



Tip

Remember that many calculators can find definite integrals.



Common Error

Make sure that you square **each term** within the brackets and do not make the mistake of squaring the whole expression inside the brackets: the formula **is not** $\pi \int_a^b (g(x) - f(x))^2 \, dx$.



Key point 10.2

The volume of revolution of the region between curves $g(x)$ and $f(x)$ is:

$$v = \pi \int_a^b (g(x)^2 - f(x)^2) dx$$

where $g(x)$ is above $f(x)$ and the curves intersect at $x = a$ and $x = b$

WORKED EXAMPLE 10.3

Find the volume formed when the region enclosed by $y = x^2 + 6$ and $y = 8x - x^2$ is rotated through 360° about the x -axis.

For points of intersection:

$$x^2 + 6 = 8x - x^2$$

$$2x^2 - 8x + 6 = 0$$

$$x^2 - 4x + 3 = 0$$

$$(x - 1)(x - 3) = 0$$

$$x = 1 \text{ or } x = 3$$

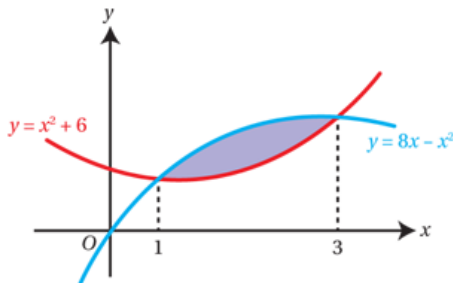

$$V = \pi \int_1^3 ((8x - x^2)^2 - (x^2 + 6)^2) dx$$

$$= \pi \int_a^b ((64x^2 - 16x^3 + x^4) - (x^4 + 12x^2 + 36)) dx$$

$$= \pi \int_1^3 (52x^2 - 16x^3 - 36) dx$$

$$= \pi \left[\frac{52}{3} x^3 - 4x^4 - 36x \right]_1^3$$

$$= \pi \left[\left(\frac{52}{3} \times 3^3 - 4 \times 3^4 - 36 \times 3 \right) \right.$$

$$\left. - \left(\frac{52}{3} \times 1^3 - 4 \times 1^4 - 36 \times 1 \right) \right]$$

$$= \frac{176}{3} \pi$$

First find the x -coordinates of the points where the curves meet, by equating the RHS of both equations and solving. This will give you the limits of integration.

Sketch the graphs in the region concerned.

$y = 8x - x^2$ is above $y = x^2 + 6$

Apply the formula.

$$v = \pi \int_a^b (g(x)^2 - f(x)^2) dx.$$

Expand and simplify.

Then evaluate the definite integral.

i Did you know?

There are also formulae to find the surface area of a solid formed by rotating a region around an axis. Some particularly interesting examples arise if you allow one end of the region to tend to infinity; for example, rotating the region formed by the lines $y = \frac{1}{x}$, $x = 1$ and the x -axis results in a solid called Gabriel's horn or Torricelli's trumpet.

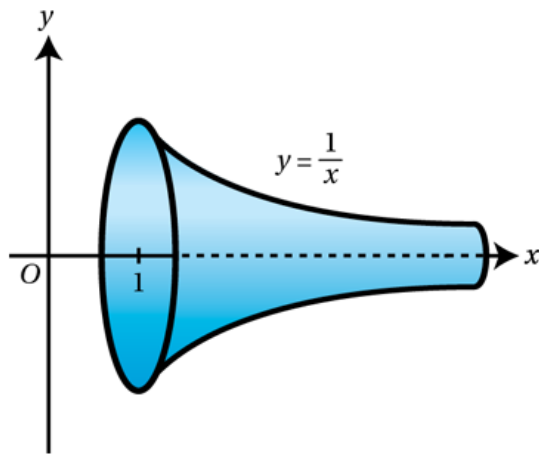

Areas and volumes can also be calculated using what are called improper integrals, and it ensues that it is possible to have a solid of finite volume but infinite surface area!

EXERCISE 10A

1 The part of the curve $y = f(x)$ for $a \leq x \leq b$ is rotated 360° about the x -axis. Find the exact volume of revolution formed in each case.

- a i $f(x) = x^2$; $a = -1$, $b = 1$
- ii $f(x) = x^3$; $a = 0$, $b = 2$
- b i $f(x) = x^2 + 6$; $a = -1$, $b = 3$
- ii $f(x) = 2x^3 + 1$; $a = 0$, $b = 1$
- c i $f(x) = \frac{1}{x}$; $a = 1$, $b = 2$
- ii $f(x) = \frac{1}{x^2}$; $a = 1$, $b = 4$

A 2 Find the exact volume of revolution formed when each curve, for $a \leq x \leq b$, is rotated through 2π radians about the x -axis.

- a i $y = e^x$; $a = 0$, $b = 1$
- ii $y = e^{-x}$; $a = 0$, $b = 3$
- b i $y = e^{2x} + 1$; $a = 0$, $b = 1$
- ii $y = e^{-x} + 2$; $a = 0$, $b = 2$
- c i $y = \sqrt{\sin x}$; $a = 0$, $b = \pi$
- ii $y = \sqrt{\cos x}$; $a = 0$, $b = \frac{\pi}{2}$

- 3** The part of the curve for $a \leq y \leq b$ is rotated 360° about the y -axis.

Find the exact volume of revolution formed in each case.

a i $y = 4x^2 + 1; a = 1, b = 17$

ii $y = \frac{x^2 - 1}{3}; a = 0, b = 5$

b i $y = x^3; a = 0, b = 8$

ii $y = x^4; a = 2, b = 8$

c i $y = \frac{1}{x^3}; a = 8, b = 27$

ii $y = \frac{1}{x^5}; a = 1, b = 32$

- A 4** The part of the curve $y = f(x)$ for $a \leq y \leq b$ is rotated 360° about the y -axis.

Find the exact volume of revolution formed in each case.

a i $f(x) = \ln x + 1; a = 1, b = 3$

ii $f(x) = \ln(2x - 1); a = 0, b = 4$

b i $f(x) = \frac{1}{x^2}; a = 1, b = 2$

ii $f(x) = \frac{1}{x^2} + 2; a = 3, b = 5$

c i $f(x) = \arcsin x; a = -\frac{\pi}{2}, b = \frac{\pi}{2}$

ii $f(x) = \arcsin x; a = -\frac{\pi}{4}, b = \frac{\pi}{4}$

- 5** The diagram shows the region, R , bounded by the curve $y = \sqrt{x - 2}$, the x -axis and the line $x = 9$.

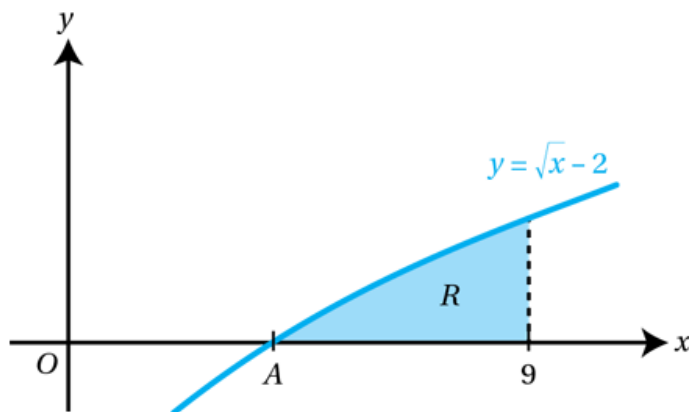

- a** Find the coordinates of the point A where the curve crosses the x -axis.

This region is rotated about the x -axis.

- b** Find the exact volume of the solid generated.

- 6** The curve $y = 3x^2 + 1$, for $0 \leq x \leq 2$, is rotated through 360° about the y -axis.

Find the volume of revolution generated, correct to 3 s.f.

- A 7** The part of the curve $y^2 = \sin x$ between $x = 0$ and $x = \frac{\pi}{2}$ is rotated through 2π radians about the x -axis.

Find the exact volume of the solid generated.

- 8** The curve $y = x^2$, for $0 < x < a$, is rotated through 180° about the x -axis. The resulting volume is $\frac{16\pi}{5}$.

Find the value of a .

- 9 The region enclosed by the curve $y = x^2 - a^2$ and the x -axis is rotated 90° about the x -axis. Find an expression for the volume of revolution formed.
- A 10 The part of the curve $y = \sqrt{\frac{3}{x}}$ between $x = 1$ and $x = a$ is rotated through 2π radians about the x -axis. The volume of the resulting solid is $\pi \ln \frac{64}{27}$. Find the exact value of a .
- 11 a Find the coordinates of the points of intersection of curves $y = x^2 + 3$ and $y = 4x + 3$.
b Find the volume of revolution generated when the region between the curves $y = x^2 + 3$ and $y = 4x + 3$ is rotated through 360° about the x -axis.
- 12 The region bounded by the curves $y = x^2 + 6$ and $y = 8x - x^2$ is rotated through 360° about the x -axis. Find the volume of the resulting shape.
- 13 a Find the coordinates of the points of intersection of the curves and $y = 4\sqrt{x}$ and $y = x + 3$
b The region between the curves and $y = 4\sqrt{x}$ and $y = x + 3$ is rotated through 360° about the y -axis. Find the volume of the solid generated.
- 14 By rotating the circle $x^2 + y^2 = r^2$ around the x -axis, prove that the volume of a sphere of radius r is given by $\frac{4}{3}\pi r^3$.
- 15 By choosing a suitable function to rotate around the x -axis, prove that the volume of a circular cone with base radius r and height h is $\frac{\pi r^2 h}{3}$.
- A 16 Find the volume of revolution when the region enclosed by the graphs of $y = e^x$, $y = 1$ and $x = 1$ is rotated through 360° about the line $y = 1$.

Section 2: Mean value of a function

Suppose an object travels between $t = 0$ s and $t = 3$ s with a velocity given by $v = t$. Its velocity-time graph looks like this.

Its average velocity can be found from:

$$\frac{\text{initial velocity} + \text{final velocity}}{2} = \frac{0 + 3}{2} \\ = 1.5$$

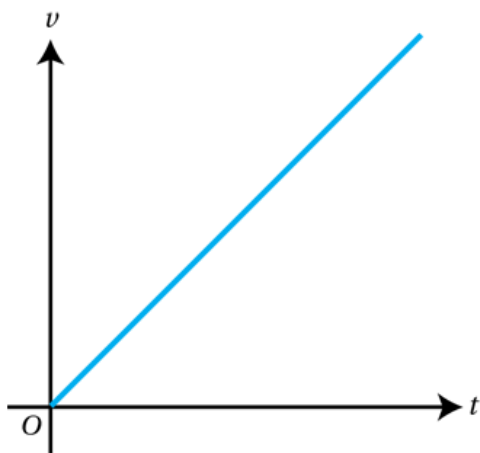

Suppose, instead, the object has velocity given by $v = \frac{t^2}{3}$. Then you can compare the two velocity–time graphs.

The formula $\frac{\text{initial velocity} + \text{final velocity}}{2}$ would give the same average velocity for the two graphs, which can't be correct because the red curve is underneath the blue line everywhere other than at the end points.

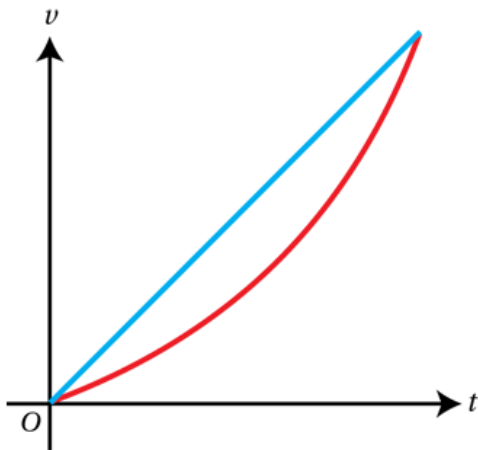

You need a measure of average that takes into account the value of the function everywhere.

One possibility is to use $\frac{\text{total distance}}{\text{time taken}}$.

You can then use the fact that total distance is the integral of velocity with respect to time.

For the blue line this gives:

$$\begin{aligned}\text{average velocity} &= \frac{\int_0^3 t \, dt}{3} \\ &= \frac{1}{3} \left[\frac{t^2}{2} \right]_0^3 \\ &= 1.5\end{aligned}$$

For the red curve this gives:

$$\begin{aligned}\text{average velocity} &= \frac{\int_0^3 \frac{t^2}{3} \, dt}{3} \\ &= \frac{1}{3} \left[\frac{t^3}{9} \right]_0^3 \\ &= 1\end{aligned}$$

This process can be generalised for any function.



Key point 10.4

The mean value of a function $f(x)$ between a and b is:

$$\frac{\int_a^b f(x) \, dx}{b - a}$$

WORKED EXAMPLE 10.4

Find the mean value of $x^2 - x$ between 3 and 4.

$$\begin{aligned} \text{Mean value} &= \frac{\int_3^4 (x^2 - x) dx}{4 - 3} \\ &= \frac{1}{4 - 3} \left[\frac{x^3}{3} - \frac{x^2}{2} \right]_3^4 \\ &= \frac{40}{3} - \frac{9}{2} \\ &= \frac{53}{6} \end{aligned}$$

Use the formula for the mean value of a function: $\frac{\int_a^b f(x) dx}{b - a}$

Notice that $x^2 - x$ varies between 6 and 12, so a mean of around 9 seems reasonable.

EXERCISE 10B

1 Find the mean value of each function between the given values of x .

- a**
- i** x^2 for $0 < x < 1$
 - ii** x^2 for $1 < x < 3$
- b**
- i** \sqrt{x} for $0 < x < 4$
 - ii** $\frac{1}{x^2}$ for $1 < x < 5$
- c**
- i** $x^3 + 1$ for $0 < x < 4$
 - ii** $x^4 - x$ for $0 < x < 10$

A 2 Find the mean value of each function over the domain given.

- a**
- i** $\sin x$ for $0 < x < \pi$
 - ii** $\cos x$ for $0 < x < \pi$
- b**
- i** e^x for $0 < x < 1$
 - ii** $\frac{1}{x}$ for $1 < x < e$
- c**
- i** $\sqrt{x+1}$ for $3 < x < 8$
 - ii** $x \sin(x^2)$ for $0 < x < \sqrt{\pi}$

3 The velocity of a rocket is given by $v = 30\sqrt{t}$ where t is time, in seconds, and v is velocity, in metres per second.

Find the mean velocity in the first T seconds.

4 The mean value of the function $x^2 - x$ for $0 < x < a$ is zero.

Find the value of a .

5 $f(x) = x^2$ for $x \geq 0$.

- a** f_{mean} is the mean value of $f(x)$ between 0 and a . Find an expression for f_{mean} in terms of a .
- b** Given that $f(c) = f_{\text{mean}}$ find an expression for c in terms of a .

6 Show that the mean value of $\frac{1}{x^2}$ between 1 and a is inversely proportional to a .

A 7 An alternating current has time period 2. The power dissipated by the current through a resistor is given by $P = P_0 \sin^2(\pi t)$.

Find the ratio of the mean power of one complete period to the maximum power.

- 8 The mean value of $f(x)$ between a and b is F .

Prove that the mean value of $f(x) + 1$ between a and b is $F + 1$.

- 9 a Sketch the graph of $\frac{1}{2\sqrt{x}}$.

b Use the graph to explain why the mean value of the function between a and b is less than the mean of $f(a)$ and $f(b)$.

c Hence prove that, if $0 < a < b$, $\sqrt{b} - \sqrt{a} < \frac{1}{3} \left(\frac{b}{\sqrt{a}} - \frac{a}{\sqrt{b}} \right)$.

- 10 If f_{mean} is the mean value of $f(x)$ for $a < x < b$ and $f(a) < f(b)$, then $f(a) < f_{\text{mean}} < f(b)$.

Either prove this statement or disprove it using a counterexample.



Checklist of learning and understanding

- The volume of a shape formed by rotating a curve about the x -axis or the y -axis is known as the volume of revolution.
 - When the curve $y = f(x)$ between $x = a$ and $x = b$ is rotated 360° about the x -axis, the volume of revolution is given by

$$V = \pi \int_a^b y^2 dx$$

- When the curve $y = f(x)$ between $y = c$ and $y = d$ is rotated 360° about the y -axis, the volume of revolution is given by

$$V = \pi \int_c^d x^2 dy$$

- The volume of revolution of the region between curves $g(x)$ and $f(x)$ is:

$$v = \pi \int_a^b (g(x)^2 - f(x)^2) dx$$

where $g(x)$ is above $f(x)$ and the curves intersect at $x = a$ and $x = b$.

- The mean value of a function $f(x)$ between a and b is:

$$\frac{\int_a^b f(x) dx}{b - a}$$

Mixed practice 10

- 1 Find the volume of revolution when the curve $y = x^2$ for $1 < x < 2$ is rotated through 360° around the x -axis.

Choose from these options.

A $\frac{27\pi}{5}$

B $\frac{31\pi}{5}$

C $\frac{32\pi}{5}$

D 15π

- 2 Find the mean value of x^3 between 1 and 4.

Choose from these options.

A $\frac{85}{4}$

B $\frac{65}{3}$

C $\frac{65}{2}$

D $\frac{255}{4}$

- 3 The curve $y = \sqrt{x}$ between 0 and a is rotated through 360° about the x -axis. The resulting shape has a volume of 18π .

Find the value of a .

- 4 For $0 < x < a$, the mean value of x is equal to the mean value of x^2 .

Find the value of a .

- 5 The mean value of $\frac{1}{\sqrt{x}}$ from 0 to b is 1.

Find the value of b .

- 6 The curve $x = \frac{y^2 - 1}{3}$, with $1 \leq y \leq 4$, is rotated through 360° about the y -axis.

Find the volume of revolution generated, correct to 3 s.f.



- 7 The diagram shows the curve with equation $y = \sqrt{100 - 4x^2}$, where $x \geq 0$.

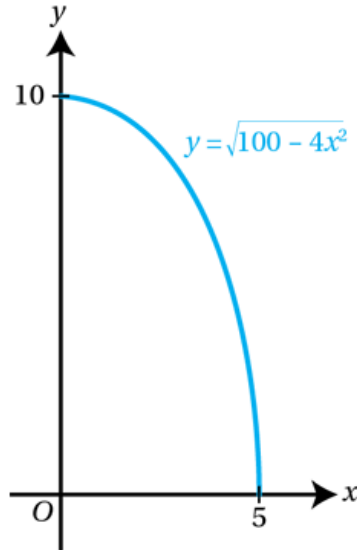

Calculate the volume of the solid generated when the region bounded by the curve shown and the coordinate axes is rotated through 360° about the y -axis, giving your answer in terms of π .

[© AQA 2009]



- 8 The diagram shows the curve with equation $y = \sqrt{(x-2)^5}$ for $x \geq 2$.

The shaded region R is bounded by the curve $y = \sqrt{(x-2)^5}$, the x -axis and the lines $x = 3$ and $x = 4$.

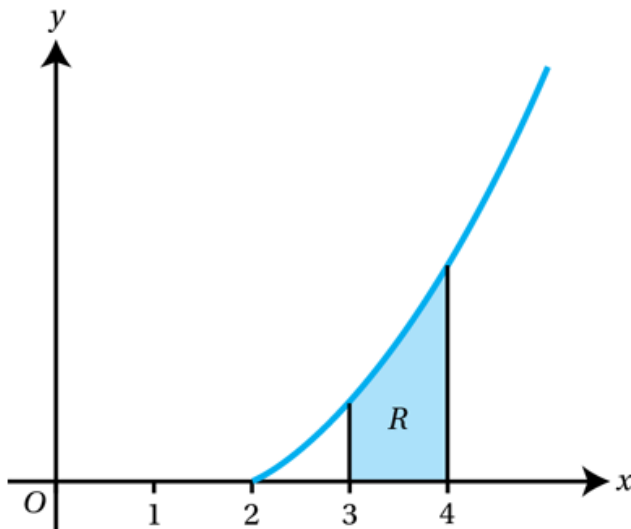

Find the exact value of the volume of the solid formed when the region R is rotated through 360° about the x -axis.

[© AQA 2009]

9 $f(x) = \frac{1}{x^2}$ for $x > 0$

a f_{mean} is the mean value of $f(x)$ between 1 and a . Find an expression for f_{mean} in terms of a .

b Given that $f(c) = f_{\text{mean}}$ find an expression for c in terms of a .

10 The region bounded by the curve $y = ax - x^2$ and the x -axis is rotated one full turn about the x -axis. Find, in terms of a , the resulting volume of revolution.

11 Prove that the mean value of x between a and b is the arithmetic mean of a and b .

A 12 The diagram shows the curve $y = \ln x$ and the line $y = -\frac{1}{e}x + 2$

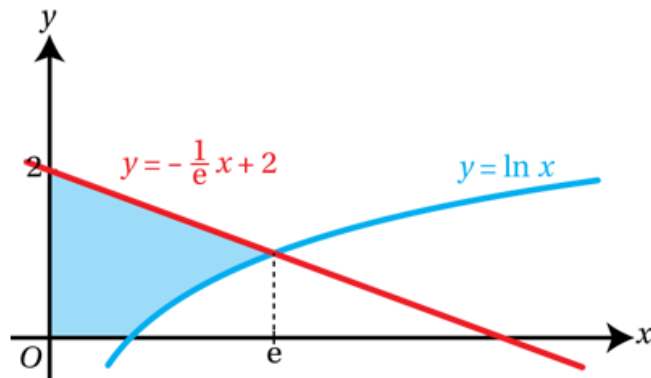

a Show that the two graphs intersect at $(e, 1)$.

The shaded region is rotated through 360° about the y -axis.

b Find the exact value of the volume of revolution.

13 The region enclosed by $y = (x - 1)(x - 2) + 1$ and the line $y = 1$ is rotated through 180° about the line $y = 1$. Find the exact value of the resulting volume.

14 The part of the curve $y = x^2 + 3$ between $y = 3$ and $y = k$ ($k > 0$) is rotated 360° about the y -axis. The volume of revolution formed is 25π .

Find the value of k .

15 Consider two curves with equations $y = x^2 - 8x + 12$ and $y = 12 + x - x^2$.

a Find the coordinates of the points of intersection of the two curves.

b The region enclosed by the curves is rotated through 360° about the x -axis. Write down an integral expression for the volume of the solid generated.

c Evaluate the volume, giving your answer to the nearest integer.

16 a The region enclosed by $y = x^2$ and $y = \sqrt{x}$ is labelled R .

Draw a sketch showing R .

b Find the volume when R is rotated through 360° about the x -axis.

c Hence find the volume when R is rotated through 360° about the y -axis.

Answers

EXERCISE 10A

1 a i 0.4π
ii $\frac{128\pi}{7}$

b i 304.8π
ii $\frac{18\pi}{7}$

c i $\frac{\pi}{2}$
ii $\frac{21\pi}{64}$

A 2 a i $\frac{\pi}{2}(e^2 - 1)$
ii $\frac{\pi}{2}(1 - e^{-6})$

b i $\pi\left(\frac{e^4}{4} + e^2 - \frac{1}{4}\right)$
ii $\pi\left(\frac{25}{2} - 4e^{-2} - \frac{e^{-4}}{2}\right)$

c i 2π
ii π

EXERCISE 10B

1 a i $\frac{1}{3}$
ii $\frac{13}{3}$

b i $\frac{4}{3}$
ii $\frac{1}{5}$

c i 17
ii 1995

A 2 a i $\frac{2}{\pi}$
ii 0
b i $e - 1$
ii $\frac{1}{e - 1}$
c i $\frac{38}{15}$
ii $\frac{1}{\sqrt{\pi}}$

3 $20\sqrt{T}$

4 1.5

3 a i 32π

ii $\frac{85}{2}\pi$

b i $\frac{96}{5}\pi$

ii $\frac{28\sqrt{2}}{3}\pi$

c i 3π

ii $\frac{35}{3}\pi$

4 a i $\frac{\pi}{2}(e^4 - 1)$

ii $\frac{\pi}{8}(e^8 + 4e^4 + 3)$

b i $\pi \ln 2$

ii $\pi \ln 3$

c i $\frac{\pi^2}{2}$

ii $(\pi - 2)\frac{\pi}{4}$

5 a $(4, 0)$

b $\frac{11\pi}{6}$

6 75.4

7 π

8 2

9 $\frac{4\pi a^5}{15}$

10 $\frac{4}{3}$

11 a $(0, 3), (4, 19)$

b 630 (3 s.f.)

12 184 (3 s.f.)

13 a $(1, 4), (9, 12)$

b $\frac{736\pi}{15}$

14 Proof.

15 Proof. Use $y = \frac{rx}{h}$.

16 $\pi\left(\frac{1}{2}e^2 - 2e + \frac{5}{2}\right)$

5 a $\frac{a^2}{3}$

b $\frac{a}{\sqrt{3}}$

6 Proof.

7 1:2

8 Proof.

9 a

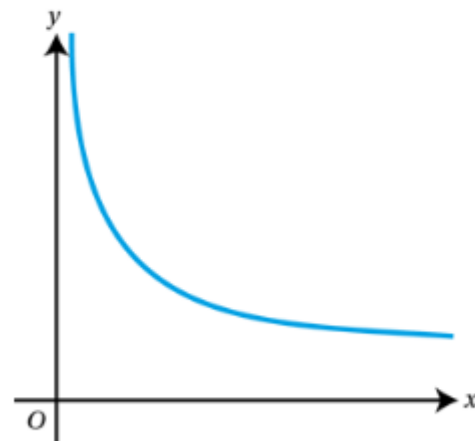

b Curve is concave up.

c Proof.

10 Not true. For example: $f(x) = x^2 - 1$ between -1 and 1.1 .

MIXED PRACTICE 10

1 B

2 A

3 6

4 $\frac{3}{2}$

5 4

6 57.8

7 $\frac{500\pi}{3}$

A 8 $\frac{21\pi}{2}$

9 a $\frac{1}{a}$

b \sqrt{a}

10 $\frac{\pi a^5}{30}$

11 Proof.

A 12 a Proof

b $\pi \left(\frac{5e^2}{6} - \frac{1}{2} \right)$

13 $\frac{\pi}{60}$

14 $3 + 5\sqrt{2}$

15 a $(0, 12)$ and $(4.5, -3.75)$

b $\pi \int_0^{4.5} (14x^3 - 111x^2 + 216x) dx$

c 787

16 a

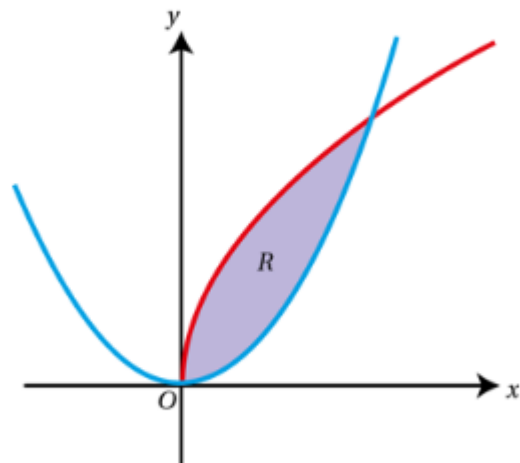

b $\frac{3\pi}{10}$

c $\frac{3\pi}{10}$

Task 4: Review - Ch. 1 Complex Numbers

Jan 05 FP1

3 It is given that $z = x + iy$, where x and y are real numbers.

(a) Write down, in terms of x and y , an expression for z^* , the complex conjugate of z .
(1 mark)

(b) Find, in terms of x and y , the real and imaginary parts of

$$2z - iz^* \quad (2 \text{ marks})$$

(c) Find the complex number z such that

$$2z - iz^* = 3i \quad (3 \text{ marks})$$

June 06 FP1

6 It is given that $z = x + iy$, where x and y are real numbers.

(a) Write down, in terms of x and y , an expression for

$$(z + i)^*$$

where $(z + i)^*$ denotes the complex conjugate of $(z + i)$.
(2 marks)

(b) Solve the equation

$$(z + i)^* = 2iz + 1$$

giving your answer in the form $a + bi$.
(5 marks)

June 07 FP1

3 It is given that $z = x + iy$, where x and y are real numbers.

(a) Find, in terms of x and y , the real and imaginary parts of

$$z - 3iz^*$$

where z^* is the complex conjugate of z .
(3 marks)

(b) Find the complex number z such that

$$z - 3iz^* = 16 \quad (3 \text{ marks})$$

Jan 08 FP1

1 It is given that $z_1 = 2 + i$ and that z_1^* is the complex conjugate of z_1 .

Find the real numbers x and y such that

$$x + 3iy = z_1 + 4iz_1^* \quad (4 \text{ marks})$$

June 08 FP1

2 It is given that $z = x + iy$, where x and y are real numbers.

(a) Find, in terms of x and y , the real and imaginary parts of

$$3iz + 2z^*$$

where z^* is the complex conjugate of z .

(3 marks)

(b) Find the complex number z such that

$$3iz + 2z^* = 7 + 8i$$

(3 marks)

June 09 FP1

3 The complex number z is defined by

$$z = x + 2i$$

where x is real.

(a) Find, in terms of x , the real and imaginary parts of:

(i) z^2 ;

(3 marks)

(ii) $z^2 + 2z^*$.

(2 marks)

(b) Show that there is exactly one value of x for which $z^2 + 2z^*$ is real.

(2 marks)

June 10 FP1

2 The complex number z is defined by

$$z = 1 + i$$

(a) Find the value of z^2 , giving your answer in its simplest form.

(2 marks)

(b) Hence show that $z^8 = 16$.

(2 marks)

(c) Show that $(z^*)^2 = -z^2$.

(2 marks)

Task 5: Review - Ch. 2 Roots of Polynomials

Jan 05 FP1

1 The equation

$$x^2 - 5x - 2 = 0$$

has roots α and β .

(a) Write down the values of $\alpha + \beta$ and $\alpha\beta$. *(2 marks)*

(b) Find the value of $\alpha^2\beta + \alpha\beta^2$. *(2 marks)*

(c) Find a quadratic equation which has roots

$$\alpha^2\beta \quad \text{and} \quad \alpha\beta^2 \quad \text{span style="float: right;">*(3 marks)*$$

June 05 FP1

6 The equation

$$x^2 - 4x + 13 = 0$$

has roots α and β .

(a) (i) Write down the values of $\alpha + \beta$ and $\alpha\beta$. *(2 marks)*

(ii) Deduce that $\alpha^2 + \beta^2 = -10$. *(2 marks)*

(iii) Explain why the statement $\alpha^2 + \beta^2 = -10$ implies that α and β cannot both be real. *(2 marks)*

(b) Find in the form $p + iq$ the values of:

(i) $(\alpha + i) + (\beta + i)$; *(1 mark)*

(ii) $(\alpha + i)(\beta + i)$. *(2 marks)*

(c) Hence find a quadratic equation with roots $(\alpha + i)$ and $(\beta + i)$. *(2 marks)*

Jan 06 FP1

5 (a) (i) Calculate $(2 + i\sqrt{5})(\sqrt{5} - i)$. *(3 marks)*

(ii) Hence verify that $\sqrt{5} - i$ is a root of the equation

$$(2 + i\sqrt{5})z = 3z^*$$

where z^* is the conjugate of z . *(2 marks)*

(b) The quadratic equation

$$x^2 + px + q = 0$$

in which the coefficients p and q are real, has a complex root $\sqrt{5} - i$.

- (i) Write down the other root of the equation. *(1 mark)*
- (ii) Find the sum and product of the two roots of the equation. *(3 marks)*
- (iii) Hence state the values of p and q . *(2 marks)*

Jan 07 FP1

1 (a) Solve the following equations, giving each root in the form $a + bi$:

(i) $x^2 + 16 = 0$; *(2 marks)*

(ii) $x^2 - 2x + 17 = 0$. *(2 marks)*

(b) (i) Expand $(1 + x)^3$. *(2 marks)*

(ii) Express $(1 + i)^3$ in the form $a + bi$. *(2 marks)*

(iii) Hence, or otherwise, verify that $x = 1 + i$ satisfies the equation

$$x^3 + 2x - 4i = 0$$
 (2 marks)

June 08 FP1

1 The equation

$$x^2 + x + 5 = 0$$

has roots α and β .

(a) Write down the values of $\alpha + \beta$ and $\alpha\beta$. *(2 marks)*

(b) Find the value of $\alpha^2 + \beta^2$. *(2 marks)*

(c) Show that $\frac{\alpha}{\beta} + \frac{\beta}{\alpha} = -\frac{9}{5}$. *(2 marks)*

(d) Find a quadratic equation, with integer coefficients, which has roots $\frac{\alpha}{\beta}$ and $\frac{\beta}{\alpha}$. *(2 marks)*

Markschemes for Tasks 4 & 5

Task 4: Complex Numbers

Jan 05 FP1

3(a)	$z^* = x - iy$	B1	1	
(b)	$R = 2x - y$ $I = -x + 2y$	B1 B1	2	$i^2 = -1$ must be used Condone $I = i(x + 2y)$; Answers may appear in (c)
(c)	Equating R and/or I parts Attempt to solve sim equations $z = 1 + 2i$	M1 m1 A1	3	Allow $x = 1, y = 2$
Total			6	

June 06 FP1

6(a)	$(z + i)^* = x - iy - i$	B2	2	
(b)	$\dots = 2ix - 2y + 1$ Equating R and I parts $x = -2y + 1, -y - 1 = 2x$ $z = -1 + i$	M1 M1 A1✓ m1A1✓	5	$i^2 = -1$ used at some stage involving at least 5 terms in all ft one sign error in (a) ditto; allow $x = -1, y = 1$
Total			7	

June 07 FP1

3(a)	Use of $z^* = x - iy$ $z - 3iz^* = x + iy - 3ix - 3y$ $R = x - 3y, I = -3x + y$	M1 m1 A1	3	Condone sign error here Condone inclusion of i in I Allow if correct in (b)
(b)	$x - 3y = 16, -3x + y = 0$ Elimination of x or y $z = -2 - 6i$	M1 m1 A1F	3	Accept $x = -2, y = -6$; ft $x + 3y$ for $x - 3y$
Total			6	

Jan 08 FP1

1	$z_1 + 4i z_1^* = (2 + i) + 4i(2 - i)$ $\dots = (2 + i) + (8i + 4)$ $\dots = 6 + 9i$, so $x = 6$ and $y = 3$	M1 M1 M1A1	4	Use of conjugate Use of $i^2 = -1$ M1 for equating Real and imaginary parts
Total			4	

June 08 FP1

2(a)	Use of $z^* = x - iy$ Use of $i^2 = -1$ $3iz + 2z^* = (2x - 3y) + i(3x - 2y)$	M1 M1 A1	3	Condone inclusion of i in I part
(b)	Equating R and I parts $2x - 3y = 7, 3x - 2y = 8$ $z = 2 - i$	M1 m1 A1	3	with attempt to solve Allow $x = 2, y = -1$
Total			6	

June 09 FP1

3(a)(i)	$z^2 = (x^2 - 4) + i(4x)$ R and I parts clearly indicated	M1A1 A1F	3	M1 for use of $i^2 = -1$ Condone inclusion of i in I part ft one numerical error
(ii)	$z^2 + 2z^* = (x^2 + 2x - 4) + i(4x - 4)$	M1A1F	2	M1 for correct use of conjugate ft numerical error in (i)
(b)	$z^2 + 2z^*$ real if imaginary part zero ... ie if $x = 1$	M1 A1F	2	ft provided imaginary part linear
Total			7	

June 10 FP1

2(a)	$z^2 = 1 + 2i + i^2 = 2i$	M1A1	2	M1 for use of $i^2 = -1$
(b)	$z^8 = (2i)^4$... = $16i^4 = 16$	M1 A1	2	or equivalent complete method convincingly shown (AG)
(c)	$(z^*)^2 = (1 - i)^2$... = $-2i = -z^2$	M1 A1	2	for use of $z^* = 1 - i$ convincingly shown (AG)
Total			6	

Task 5: Roots of Polynomials

Jan 05 FP1

1(a)	$\alpha + \beta = 5, \alpha\beta = -2$	B1, B1	2	
(b)	$\alpha^2\beta + \alpha\beta^2 = \alpha\beta(\alpha + \beta) = -10$	M1A1✓	2	ft wrong values
(c)	$(\alpha^2\beta)(\alpha\beta^2) = (\alpha\beta)^3 = -8$ Equation is $x^2 + 10x - 8 = 0$	M1A1✓ A1✓	3	ft wrong values Dep on both M1s; ft wrong values; Condone omission of “= 0”
Total			7	

June 05 FP1

6(a)(i)	$\alpha + \beta = 4, \alpha\beta = 13$	B1B1	2	
(ii)	$\alpha^2 + \beta^2 = (\alpha + \beta)^2 - 2\alpha\beta$... = $4^2 - 26 = -10$	M1 A1	2	convincingly shown (AG)
(iii)	The square of a real number is positive (or zero) The sum of two such squares is positive (or zero)	E1 E1	2	
(b)(i)	$(\alpha + i) + (\beta + i) = 4 + 2i$	B1F	1	ft wrong value in (a)(i)
(ii)	$(\alpha + i)(\beta + i) = 12 + 4i$	M1A1F	2	ditto
(c)	Correct coeff of x or constant term $x^2 - (4 + 2i)x + (12 + 4i) = 0$	M1 A1F	2	Using c's answers in (b) ft wrong answers in (b)
Total			11	

Jan 06 FP1

5(a)(i)	Full expansion of product Use of $i^2 = -1$ $(2 + \sqrt{5}i)(\sqrt{5} - i) = 3\sqrt{5} + 3i$	M1 m1 A1	3	$\sqrt{5}\sqrt{5} = 5$ must be used – Accept not fully simplified
(ii)	$z^* = x - iy (= \sqrt{5} + i)$ Hence result	M1 A1	2	
(b)(i)	Other root is $\sqrt{5} + i$	B1	1	Convincingly shown (AG)
(ii)	Sum of roots is $2\sqrt{5}$ Product is 6	B1 M1A1	3	
(iii)	$p = -2\sqrt{5}, q = 6$	B1 B1 \checkmark	2	
Total			11	

Jan 07 FP1

1(a)(i)	Roots are $\pm 4i$	M1A1	2	M1 for one correct root or two correct factors
(ii)	Roots are $1 \pm 4i$	M1A1	2	M1 for correct method
(b)(i)	$(1 + x)^3 = 1 + 3x + 3x^2 + x^3$	M1A1	2	M1A0 if one small error
(ii)	$(1 + i)^3 = 1 + 3i - 3 - i = -2 + 2i$	M1A1	2	M1 if $i^2 = -1$ used
(iii)	$(1 + i)^3 + 2(1 + i) - 4i$ $\dots = (-2 + 2i) + (2 - 2i) = 0$	M1 A1	2	with attempt to evaluate convincingly shown (AG)
Total			10	

June 08 FP1

1(a)	$\alpha + \beta = -1, \alpha\beta = 5$	B1B1	2	with numbers substituted ft sign error(s) in (a)
(b)	$\alpha^2 + \beta^2 = (\alpha + \beta)^2 - 2\alpha\beta$ $\dots = 1 - 10 = -9$	M1 A1F	2	
(c)	$\frac{\alpha}{\beta} + \frac{\beta}{\alpha} = \frac{\alpha^2 + \beta^2}{\alpha\beta}$ $\dots = -\frac{9}{5}$	M1 A1	2	AG: A0 if $\alpha + \beta = 1$ used
(d)	Product of new roots is 1 Eqn is $5x^2 + 9x + 5 = 0$	B1 B1F	2	PI by constant term 1 or 5 ft wrong value for product
Total			8	